

BX Series

■ Features

- Timer function selection : Timer built in
- Reverse power polarity protection and over current protection built in
- Wide range of power supply :
Common use of 24–240VDC/24–240VAC
- Good water proof structure : IP66 (IEC specification)
- Various output types :
NPN/PNP open collector output (DC power type)
Relay contact output (AC power type)



※ MS-4 is optional.

⚠ Please read "Caution for your safety" in operation manual before using.



■ Specifications

● Free power type

Model	Standard type	BX15M-TFR	BX5M-MFR	BX3M-PFR	BX700-DFR
	Built-in Timer	BX15M-TFR-T	BX5M-MFR-T	BX3M-PFR-T	BX700-DFR-T
Type		Through-beam	Retroreflective	Retroreflective(polarizing filter)	Diffuse reflective
Detecting distance		15m	(*1) 0.1 ~ 5m (MS-2)	(*2) 0.1 ~ 3m (MS-3)	(*3) 700mm
Detecting target		Opaque materials of Min. ϕ 15mm	Opaque materials of Min. ϕ 60mm		Transparent, Translucent, Opaque material
Hysteresis		—	—		Max. 20% at rated setting distance
Response time		Max. 20ms			
Power supply		24–240VAC \pm 10% 50/60Hz, 24–240VDC \pm 10% (Ripple P-P:Max. 10%)			
Current consumption		Max. 3VA			
Light source		Infrared LED (Modulated)		Red LED (Modulated:660nm)	Infrared LED (Modulated)
Sensitivity adjustment		Adjustable by VR			
Operation mode		Selectable Light ON or Dark ON by slide switch			
Control output		Relay contact output \Rightarrow Contact capacity : 30VDC 3A, 250VAC 3A at resistive load, Contact composition: 1c (SPDT)			
Relay life cycle		Mechanically : Min. 50,000,000, Electrically : Min. 100,000			
Self-diagnosis output		Green LED turns on at unstable operation			
Timer function		Selectable ON Delay, OFF Delay, One Shot Delay by slide switch [Delay Time : 0.1 ~ 5sec (VR adjustable)]			
Indication		Operation indicator : Yellow LED, Self-diagnosis indicator : Green LED			
Connection		Terminal connection			
Insulation resistance		Min. 20M Ω (at 500VDC)			
Insulation type		Double insulation			
Noise strength		\pm 1,000V the square wave noise (pulse width:1 μ s) by the noise simulator			
Dielectric strength		1500VAC 50/60Hz for 1minute			
Impulse dielectric strength		1kV (Generator : 1.2/50 μ s, Source impedance : 500 Ω , Source energy : 0.5J)			
Vibration	Mechanical	1.5mm amplitude at frequency of 10 ~ 55Hz in each of X, Y, Z directions for 2 hours			
	Malfunction	1.5mm amplitude at frequency of 10 ~ 55Hz in each of X, Y, Z directions for 10 minutes			
Shock	Mechanical	500m/s ² (50G) in X, Y, Z directions for 3 times			
	Malfunction	100m/s ² (10G) in X, Y, Z directions for 3 times			
Ambient illumination		Sunlight : Max. 11,000lx, Incandescent lamp : Max. 3,000lx			
Ambient temperature		-20 ~ +65 $^{\circ}$ C (at non-freezing status), Storage : -25 ~ +70 $^{\circ}$ C			
Ambient humidity		35 ~ 85%RH, Storage : 35 ~ 85%RH			
Protection		IP66 (IEC specification)			
Material		Case : ABS, Lens : PMMA			
Accessory	Individual	—	Mirror (MS-2)	Mirror (MS-3)	—
	Common	Adjustment driver, Mounting bracket, Bolts/Nuts			
Approval		CE			
Weight		TFR : Approx. 198g, TFR-T : Approx. 203g	MFR : Approx. 126g, MFR-T : Approx. 131g	PFR : Approx. 130g, PFR-T : Approx. 134g	DFR : Approx. 110g, DFR-T : Approx. 115g

※ (*1) It is same when using MS-4. It is detectable under 0.1m.

※ (*2) Using MS-2, Detecting distance will be 0.1~2m, it is detectable under 0.1m.

※ (*3) It is for Non-glossy white paper (200 \times 200mm)

AC/DC Large Size Housing & Long Distance Type

●DC power type

Model	Standard type	BX15M-TDT	BX5M-MDT	BX3M-PDT	BX700-DDT	BX15M-TDT-P	BX5M-MDT-P	BX3M-PDT-P	BX700-DDT-P
	Built-in Timer	BX15M-TDT-T	BX5M-MDT-T	BX3M-PDT-T	BX700-DDT-T	BX15M-TDT-TP	BX5M-MDT-TP	BX3M-PDT-TP	BX700-DDT-TP
Type	Through-beam	Retroreflective	Retroreflective (polarizing)	Diffuse reflective	Through-beam	Retroreflective	Retroreflective (polarizing)	Diffuse reflective	
Detecting distance	15m	(*1) 0.1 ~ 5m (MS-2)	(*2) 0.1 ~ 3m (MS-3)	(*3) 700mm	15m	(*1) 0.1 ~ 5m (MS-2)	(*2) 0.1 ~ 3m (MS-3)	(*3) 700mm	
Detecting target	Opaque materials of Min. ϕ 15mm	Opaque materials of Min. ϕ 60mm	Opaque materials of Min. ϕ 60mm	Transparent, Translucent, Opaque material	Opaque materials of Min. ϕ 15mm	Opaque materials of Min. ϕ 60mm	Opaque materials of Min. ϕ 60mm	Transparent, Translucent, Opaque material	
Hysteresis	—	—	—	Max. 20% at rated setting distance	—	—	—	Max. 20% at rated setting distance	
Response time	Max. 1ms								
Power supply	12-24VDC \pm 10% (Ripple P-P:Max. 10%)								
Current consumption	Max. 40mA	Max. 30mA			Max. 40mA	Max. 30mA			
Light source	Infrared LED (Modulated)		Red LED (Modulated: 660nm)	Infrared LED (Modulated)	Infrared LED (Modulated)		Red LED (Modulated: 660nm)	Infrared LED (Modulated)	
Sensitivity adjustment	Adjustable by VR								
Operation mode	Selectable Light ON or Dark ON by slide switch								
Control output	<ul style="list-style-type: none"> • NPN open collector output \Rightarrow Load voltage : Max. 30VDC, Load current : Max. 200mA Residual voltage : Max. 1V at 200mA, Max. 0.4V at 16mA 				<ul style="list-style-type: none"> • PNP open collector output (Yellow LED) \Rightarrow Output voltage : Min. power supply-2.5V Load current : Max. 200mA 				
Self-diagnosis output	NPN open collector output \Rightarrow Load voltage : Max. 30VDC, Load current : Max. 50mA, Residual voltage : Max. 1V at 50mA, Max. 0.4V at 16mA								
Protection circuit	Reverse polarity protection, Overload & short circuit protection								
Timer function	Selectable ON Delay, OFF Delay, One Shot Delay by slide switch [Delay Time : 0.1 ~ 5sec (VR adjustable)]								
Indication	Operation indicator : Yellow LED, Self-diagnosis indicator : Green LED								
Connection	Terminal connection								
Insulation resistance	Min. 20M Ω (at 500VDC)								
Noise strength	\pm 240V the square wave noise (pulse width:1 μ s) by the noise simulator								
Dielectric strength	1000VAC 50/60Hz for 1minute								
Vibration	1.5mm amplitude at frequency of 10 ~ 55Hz in each of X, Y, Z directions for 2 hours								
Shock	500m/s ² (50G) in X, Y, Z directions for 3 times								
Ambient illumination	Sunlight : Max. 11,000lx, Incandescent lamp : Max. 3,000lx								
Ambient temperature	-20 ~ +65 $^{\circ}$ C (at non-freezing status), Storage : -25 ~ +70 $^{\circ}$ C								
Ambient humidity	35 ~ 85%RH, Storage : 35 ~ 85%RH								
Protection	IP66 (IEC specification)								
Material	Case : ABS, Lens cover : Acryl, Lens : Acryl								
Accessory	Individual	—	Mirror (MS-2)	Mirror (MS-3)	—	—	Mirror (MS-2)	Mirror (MS-3)	—
	Common	Adjustment driver, Mounting bracket, Bolts/Nuts							
Approval	CE								
Weight	TDT : Approx.183g, TDT-T : Approx.188g	MDT : Approx.110g, MDT-T : Approx.115g	PDT : Approx.114g, PDT-T : Approx.119g	DDT : Approx.95g, DDT-T : Approx.100g	TDT-P : Approx.183g, TDT-TP : Approx.188g	MDT-P : Approx.110g, MDT-TP : Approx.115g	PDT-P : Approx.114g, PDT-TP : Approx.119g	DDT-P : Approx.95g, DDT-TP : Approx.100g	

※(*1)It is the same when using MS-4. It is detectable under 0.1m.

※(*2)Using MS-2, Detecting distance will be 0.1~2m, it is detectable under 0.1m.

※(*3)It is for Non-glossy white paper(200 \times 200mm).

(A)
Counter

(B)
Timer

(C)
Temp.
controller

(D)
Power
controller

(E)
Panel
meter

(F)
Tacho/
Speed/
Pulse
meter

(G)
Display
unit

(H)
Sensor
controller

(I)
Proximity
sensor

(J)
Photo
electric
sensor

(K)
Pressure
sensor

(L)
Rotary
encoder

(M)
5-Phase
stepping
motor &
Driver &
Controller

BX Series

Characteristic

Through-beam

- BX15M-TFR / BX15M-TFR-T
- BX15M-TDT / BX15M-TDT-T
- BX15M-TDT-P / BX15M-TDT-TP

Diffuse reflective

- BX700-DFR / BX700-DFR-T
- BX700-DDT / BX700-DDT-T
- BX700-DDT-P / BX700-DDT-TP

Parallel shifting characteristic		Angle Characteristic		Detecting area	
Measuring method	Data	Measuring method	Data	Measuring method	Data
<p>Receiver</p> <p>Emitter</p> <p>Operation level</p> <p>Stable operation level</p>	<p>Detecting distance L (m)</p> <p>Left ← Center → Right</p> <p>Operation position l_1 (mm)</p>	<p>Receiver</p> <p>Emitter</p>	<p>Detecting distance L (m)</p> <p>Left ← Center → Right</p> <p>Operation angle θ</p>	<p>Standard detecting target: non-glossy white paper 100×100mm</p> <p>Diffuse reflective</p>	<p>Detecting distance L (m)</p> <p>Left ← Center → Right</p> <p>Operation position l_1 (mm)</p>

Retroreflective

- BX5M-MFR / BX5M-MFR-T
- BX5M-MDT / BX5M-MDT-T
- BX5M-MDT-P / BX5M-MDT-TP

Parallel shifting characteristic		Sensor angle characteristic		Mirror angle characteristic	
Measuring method	Data	Measuring method	Data	Measuring method	Data
<p>Mirror (MS-2)</p> <p>Retroreflective</p>	<p>Detecting distance L (m)</p> <p>Left ← Center → Right</p> <p>Operation position l_1 (mm)</p>	<p>Mirror (MS-2)</p> <p>Retroreflective</p>	<p>Detecting distance L (m)</p> <p>Left ← Center → Right</p> <p>Operation angle θ</p>	<p>Mirror (MS-2)</p> <p>Retroreflective</p>	<p>Detecting distance L (m)</p> <p>Left ← Center → Right</p> <p>Operation angle θ</p>

Retroreflective with polarizing filter

- BX3M-MFR / BX3M-MFR-T
- BX3M-MDT / BX3M-MDT-T
- BX3M-MDT-P / BX3M-MDT-TP

Parallel shifting characteristic		Sensor angle characteristic		Mirror angle characteristic	
Measuring method	Data	Measuring method	Data	Measuring method	Data
<p>Mirror (MS-3)</p> <p>Retroreflective</p>	<p>Detecting distance L (m)</p> <p>Left ← Center → Right</p> <p>Operation position l_1 (mm)</p>	<p>Mirror (MS-3)</p> <p>Retroreflective</p>	<p>Detecting distance L (m)</p> <p>Left ← Center → Right</p> <p>Operation angle θ</p>	<p>Mirror (MS-3)</p> <p>Retroreflective</p>	<p>Detecting distance L (m)</p> <p>Left ← Center → Right</p> <p>Operation angle θ</p>

AC/DC Large Size Housing & Long Distance Type

Control output diagram

○ Free power

◎ DC power

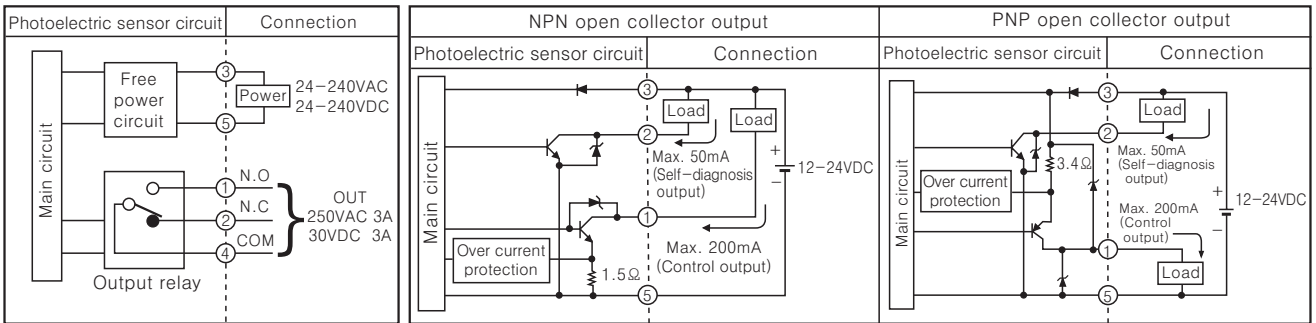

※In case of product with the output protection device, if terminals of control output are short-circuited or if over current condition exists, the control output will turn off due to protection circuit.

Operation mode and timing chart

Light ON mode

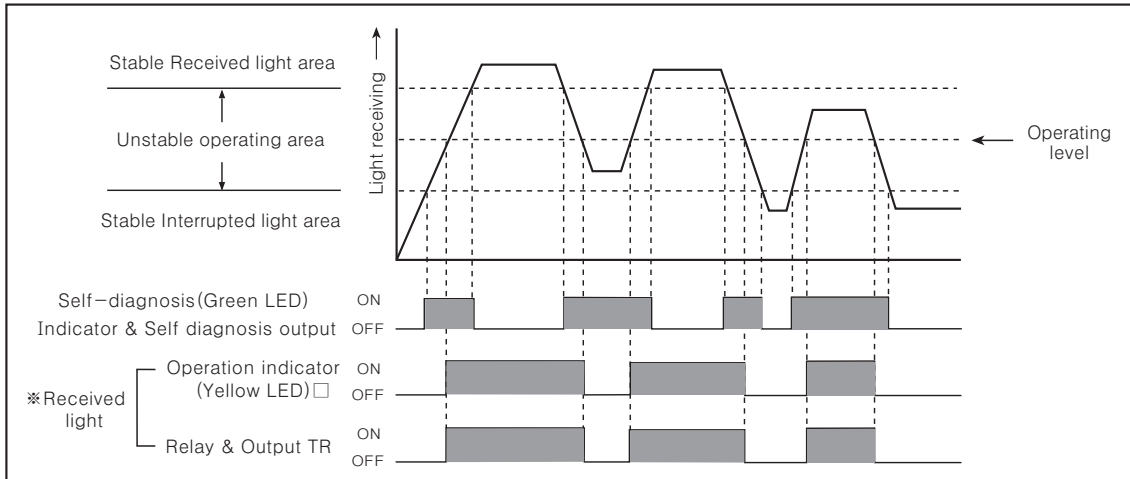

※Operation for Dark ON mode is opposed to above chart indication for Light ON mode.

※To prevent from the misoperation, output of units keeps the state of OFF for 0.5sec. after power ON.

Timer mode

Timer mode	SW position		Status of detection	Received light	Interrupted light
	SW1	SW2			
Normal Mode (No delay)	ON	ON	Light ON	ON	[Timing diagram showing pulse]
			Dark ON	OFF	[Timing diagram showing pulse]
One Shot Delay Mode	ON	OFF	Light ON	ON	[Timing diagram showing pulse with delay T]
			Dark ON	OFF	[Timing diagram showing pulse with delay T]
ON Delay Mode	OFF	ON	Light ON	ON	[Timing diagram showing pulse with delay T]
			Dark ON	OFF	[Timing diagram showing pulse with delay T]
OFF Delay Mode	OFF	OFF	Light ON	ON	[Timing diagram showing pulse with delay T]
			Dark ON	OFF	[Timing diagram showing pulse with delay T]

※T : Time set by timer VR.

(A) Counter

(B) Timer

(C) Temp. controller

(D) Power controller

(E) Panel meter

(F) Tacho/Speed/Pulse meter

(G) Display unit

(H) Sensor controller

(I) Proximity sensor

(J) Photo electric sensor

(K) Pressure sensor

(L) Rotary encoder

(M) 5-Phase stepping motor & Driver & Controller

BX Series

Connections

Through-beam

●BX15M-TFR1

●BX15M-TFR 2,
BX15M-TFR-T2

●BX15M-TDT1

●BX15M-TDT2,
BX15M-TDT-T2
●BX15M-TDT-P2,
BX15M-TDT-TP2

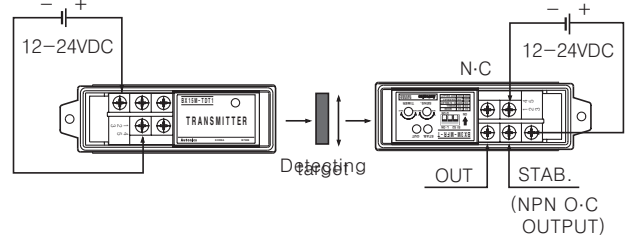
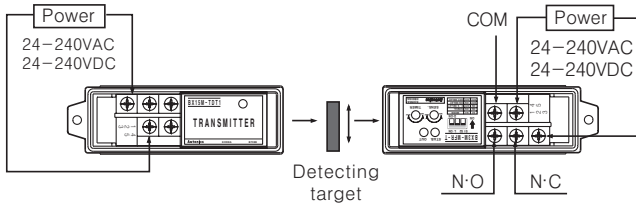

Retroreflective/Retroreflective with polarizing filter

●BX5M-MFR, BX5M-MFR-T
●BX3M-PFR, BX3M-PFR-T

●BX5M-MDT, BX5M-MDT-T ●BX5M-MDT-P, BX5M-MDT-TP
●BX3M-PDT, BX3M-PDT-T ●BX3M-PDT-P, BX3M-PDT-TP

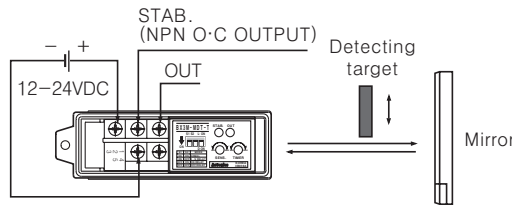
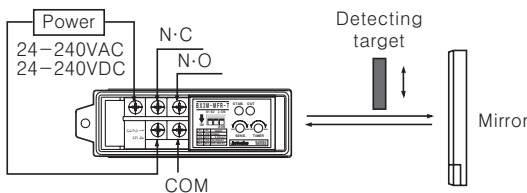

Diffuse reflective

●BX700-DFR, BX700-DFR-T

●BX700-DDT, BX700-DDT-T
●BX700-DDT-P, BX700-DDT-TP

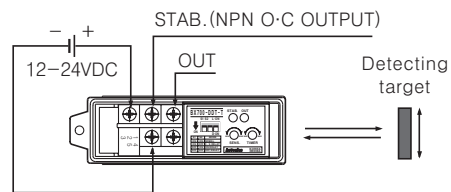
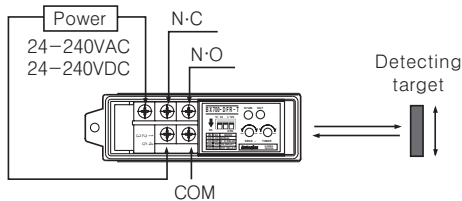

Cable

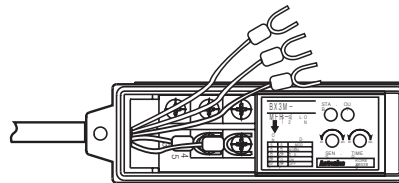
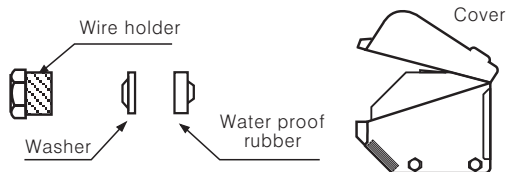
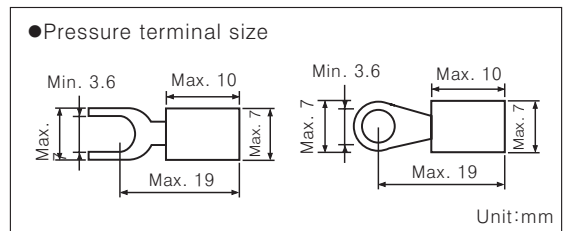
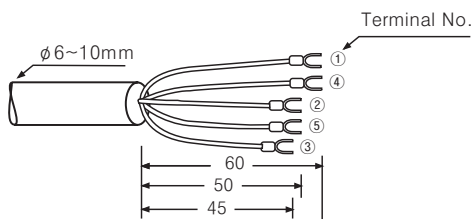

- ※On servicing wire, connect wire on terminal as above figure.
- ※You shall select the round wire with the size of $\phi 6 \sim 10\text{mm}$ for the water proof and tighten the cable holder by torque of $1.0 \sim 1.5\text{N} \cdot \text{m}$.
- ※On servicing wire, tighten screw of terminals by torque of $0.8\text{N} \cdot \text{m}$.
- ※On mounting the cover, tighten the cover nut by torque of $0.3 \sim 0.5\text{N} \cdot \text{m}$.

AC/DC Large Size Housing & Long Distance Type

Front panel identification

○Through-beam

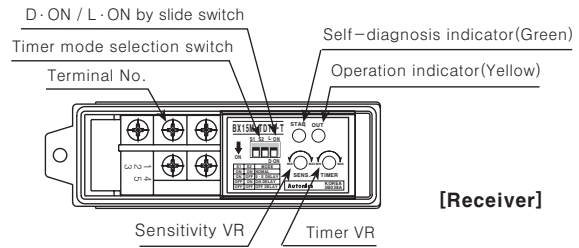
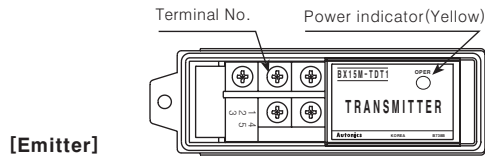

○Retroreflective (Polarizing filter)

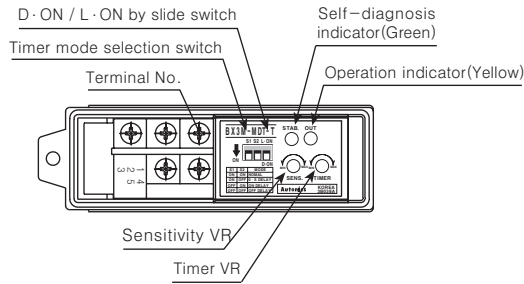

○Diffuse reflective

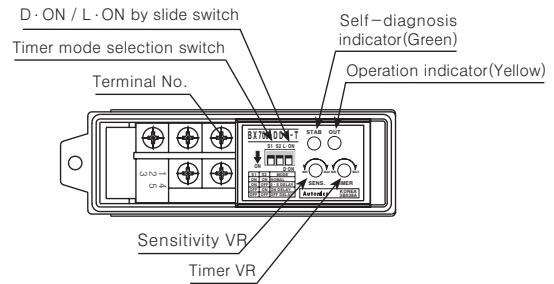

※ There are no Timer mode selection switch and Timer VR in type which has not Timer function.

Dimensions

Unit:mm

Product

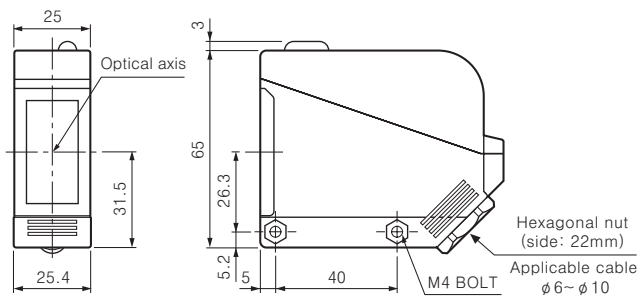
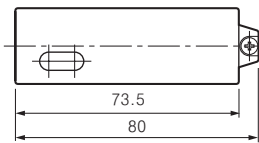

Bracket

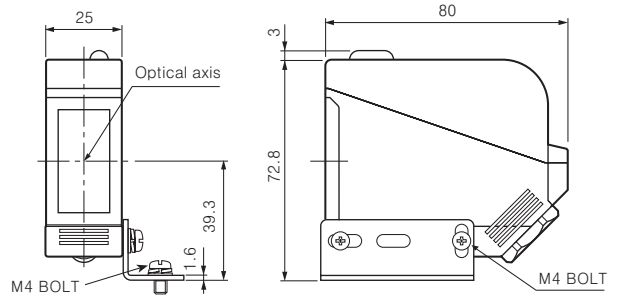
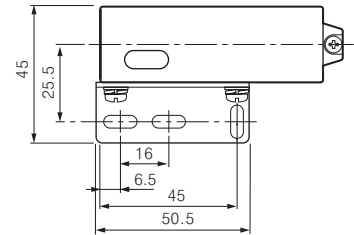

Bracket

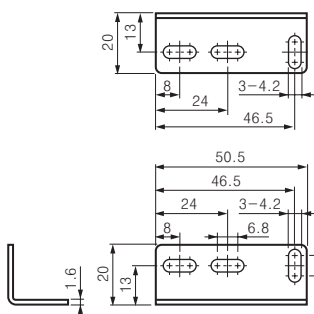

MS-2

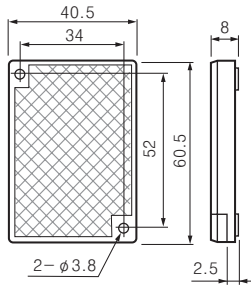

MS-3

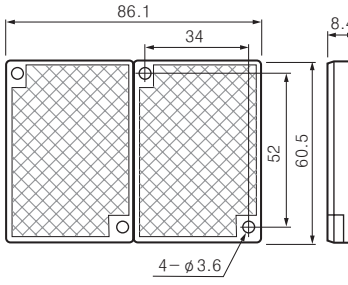

MS-4

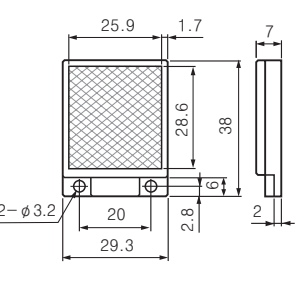

- (A) Counter
- (B) Timer
- (C) Temp. controller
- (D) Power controller
- (E) Panel meter
- (F) Tacho/Speed/Pulse meter
- (G) Display unit
- (H) Sensor controller
- (I) Proximity sensor
- (J) Photo electric sensor
- (K) Pressure sensor
- (L) Rotary encoder
- (M) 5-Phase stepping motor & Driver & Controller

BX Series

■ Mounting & Adjustment

◎ Through-beam type

1. Supply the power to the photoelectric sensor, after the emitter and the receiver in face to face.
2. Set the receiver in center of position where indicator turns on, as adjusting the receiver or the emitter right and left, up and down.
3. Fix both units tightly after checking that the unit detects the target.

※ If the detecting target is translucent body or smaller than $\phi 15\text{mm}$, it might not detect the target cause light passed.

※ Sensitivity adjustment : Please see the diffuse reflective type.

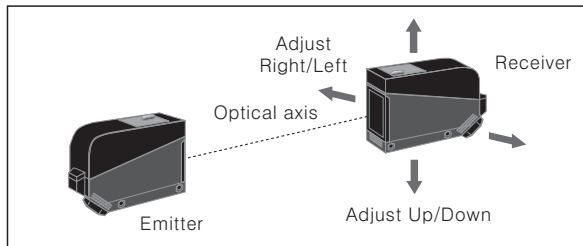

◎ Diffuse reflective type

1. Even though the diffuse reflective type is set at Max. sensitive position, the sensitivity of the sensor must be adjusted according to the existence of the reflective material background.
2. Set the target at a position and turn sensitivity volume from minimum sensitivity position slowly, confirm ① position where indicator (Yellow LED) is ON and self-diagnosis indicator (Green LED) is OFF.
3. If turn volume higher slowly in state of removed target, the operation indicator (Yellow LED) will be OFF and self-diagnosis indicator (Green LED) will be ON. Confirm this position as ②.
[When self-diagnosis indicator (Green LED) and operation indicator (Yellow LED) are OFF, the Max. sensitivity position will be ②.]
4. Set the adjuster at the center of two switching point ①, ②.

※ Above sensitivity adjustment is when it is the state of Light ON mode. If it is the state of Dark ON mode, operation indicator (Yellow LED) will be opposite.

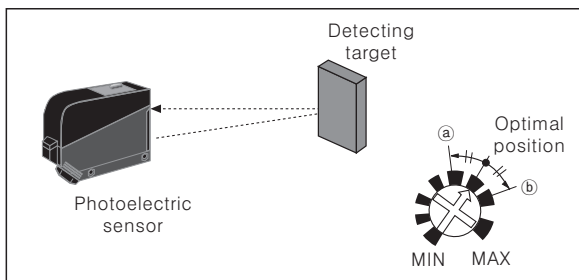

※ The detecting distance indicated on specification chart is against $200 \times 200\text{mm}$ of non-glossy white paper. Be sure that it can be different by size, surface and gloss of target.

◎ Retroreflective type

1. Supply the power to the photoelectric sensor, after setting the photoelectric sensor and the mirror (MS-2) in face to face.
2. Set the photoelectric sensor in the position which indicator turns on, as adjusting the mirror or the sensor right and left, up and down.
3. Fix both units tightly after checking that the unit detects the target.

※ If use more than 2 photoelectric sensor in parallel, the space between them should be more than 30cm.

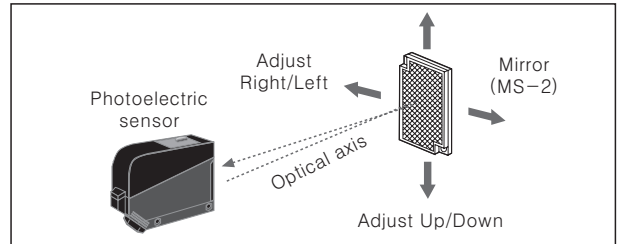

※ If use more than 2 photo sensors in parallel, the space between them should be more than 30cm.

※ If reflectance of target is higher than non-glossy white paper, it might cause malfunction by reflection from the target when the target is near to photo sensor. Therefore put enough space between the target and photoelectric sensor or the surface of target should be installed at an angle of $30^\circ \sim 45^\circ$ against optical axis. (When detect target with high reflectance near by, photoelectric sensor with the polarizing filter should be used.)

※ Sensitivity adjustment : Please see the diffuse reflective type.

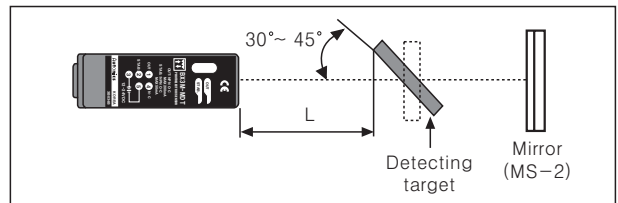

※ If the installing place is too small, please use MS-4 instead of MS-2. It makes same detecting distance.

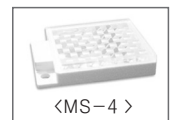

◎ Retroreflective type (With polarizing filter)

When the passes through polarizing filter from emitter, it will be converted as horizontal transverse beam and reaches to mirror MS-2 (MS-3), after wards it is converted by mirror function as vertical beam and reaches to receiver through polarizing filter. Even it can detect normal mirror.

